

Model

Designation	GTK80AT	200-240V/50Hz 1~	Sales code:	CDO00155
-------------	----------------	-------------------------	-------------	-----------------

Compressor design

Oil type	Polyolester	Refrigerant(s)	R134a
Oil viscosity	15cSt	Displacement	7,7cm ³ / 0,47cu.in
Oil quantity	156cm ³ / 5,3fl.oz	Compressors on pallet	100
Refr. charge - tech. limit			
Free gas volume comp.	1560cm ³ / 52,7fl.oz		
Weight	9,1kg / 20,1lbs		
Motor protection	external		
Winding resistance main	10,6Ω (at 25°C)		
Winding resistance aux	17Ω (at 25°C)		
Max. winding temp.	130°C / 266°F		
Max. discharge temp.	130°C / 266°F		



General - Configurations with GTK80AT

	Conf. 1	Conf. 2
Motorconfiguration	RSCR	RSIR
Power supply (nominal)	200-240V/50Hz	200-240V/50Hz
Number of phases	1	1
Voltage range	170-264V	170-264V
Approvals	VDE, EAC	VDE, EAC
Starting torque	LST	LST
Note	- / -	

Applications with GTK80AT

	Conf. 1	Conf. 2
Refrigerant	R134a	R134a
Application	LBP	LBP
System cooling	static	static
Hot gas defrost	- / -	- / -
Long interval pull down	- / -	- / -

Electrical data - Configurations with GTK80AT

	Conf. 1	Conf. 2
Starting device type	PTC	PTC
Run capacitor	4μF	0μF
Start capacitor	0μF	0μF
LRA (locked rotor amps / 4s)	8,2A	8,2A
RLA (rated load amps / 1s)		
Cut in current	15,5A	15,5A
IP class	21	21

Model

Designation	GTK80AT	200-240V/50Hz 1~	Sales code:	CDO00155
-------------	----------------	------------------	-------------	-----------------

Compressor dimensions

Housing	A Height	177mm / 6,97in
	B Height	170mm / 6,69in
	C Length shell	191mm / 7,52in
	D Length w. cover	215mm / 8,46in
	E Width	151mm / 5,94in

Connectors		Suction	Discharge	Process
		X	Y	Z
Diameter	[mm]	øi 6,1-6,2	øi 5,1-5,2	øo 5,92-6,08
(i:inside, o:outside)	[in]	øi 0,24-0,24	øi 0,2-0,2	øo 0,23-0,24
Material		copper	copper	copper
Horizontal angle	±2°	45°	13°	0
Vertical angle	±2°	30°	40°	145°
Position l/h/w	[mm]	120/72/62	112/106/62	-140/136/70
	[in]	4,7/2,8/2,4	4,4/4,2/2,4	-5,5/5,4/2,8
Straight tube l.	[mm]	14	14	14
	[in]	0,5	0,5	0,5

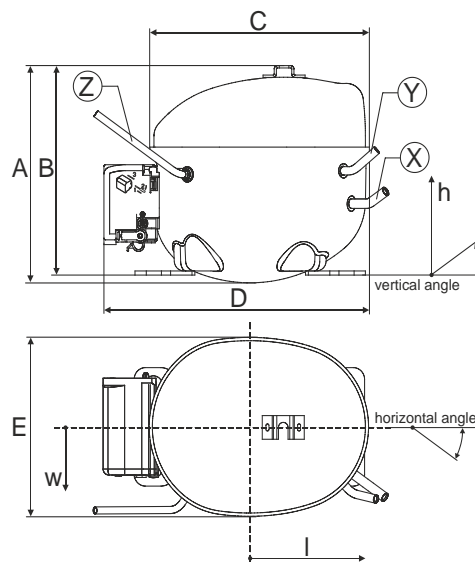

Compressor fixation

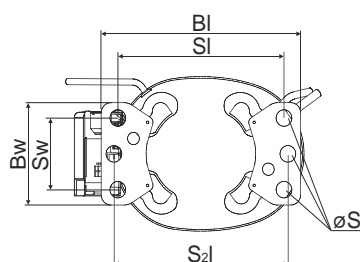

Baseplate	[mm]	[inch]
BI	204	8.03
BW	100	3.94
Small holes		
SI	170	6.7
SW	70	2.76
S2l	178	7
øS	ø 16	ø 0.63

Bolt joint

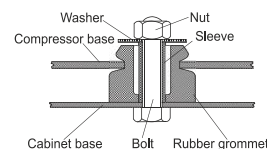

Snap-on

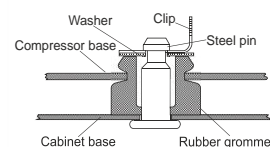

Mounting accessories

'4ZN' with rubber grommet

'4ZN' with rubber grommet and sleeve for M6

Bolt joint kit

'4ZN' with Snap on kit

order code

772N

768N

4ZN + 118-1917 (18)

776N

Application notes

Various options of housing are possible (dip-tray fixture) - please contact Nidec-Sales.

Various options of connectors are possible - please contact Nidec-Sales.

Model

Designation **GTK80AT** **200-240V/50Hz** **Conf. 1** Sales code: **CDO00155**

Configuration

Motorconfiguration **RSCR**
 Power supply (nominal) **200-240V/50Hz 1~**
 Refrigerant **R134a**
 Application **LBP**
 Voltage range **170-264V**
 Starting torque **LST**
 Approvals **VDE**
EAC

Electrical accessories / wiring diagram

RSCR

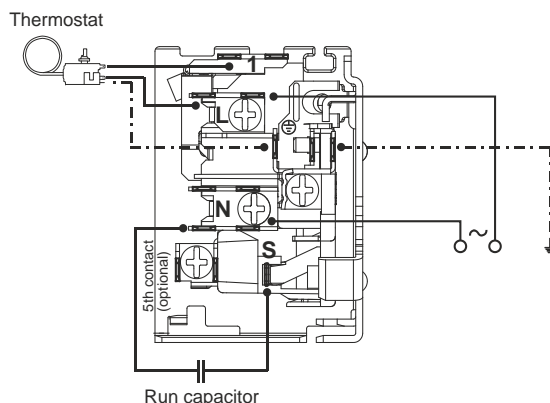
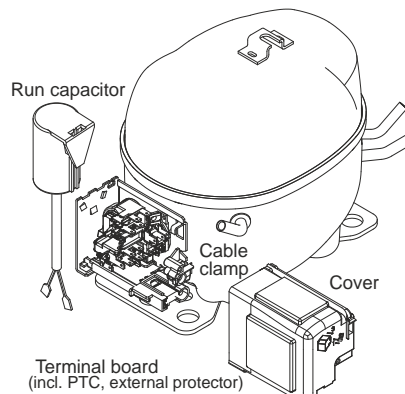

Ambient temperatures / system cooling

Ambient temperature min.: **10°C / 50°F**
 Ambient temperature max.: **43°C / 110°F**

System cooling			
T ambient	LBP	MBP	HBP
32°C / 90°F	static	n/a	n/a
38°C / 100°F	static	n/a	n/a
43°C / 110°F	static	n/a	n/a

Operation pressure range

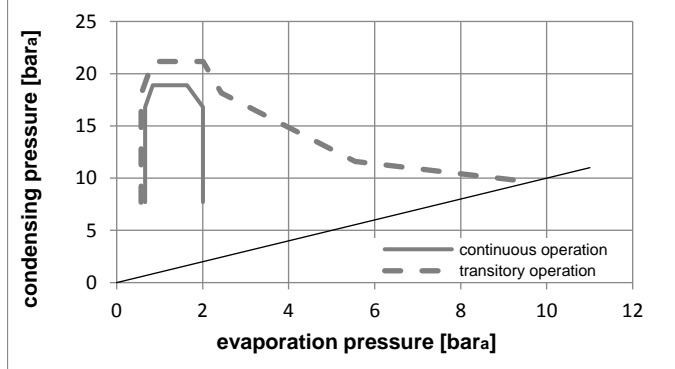
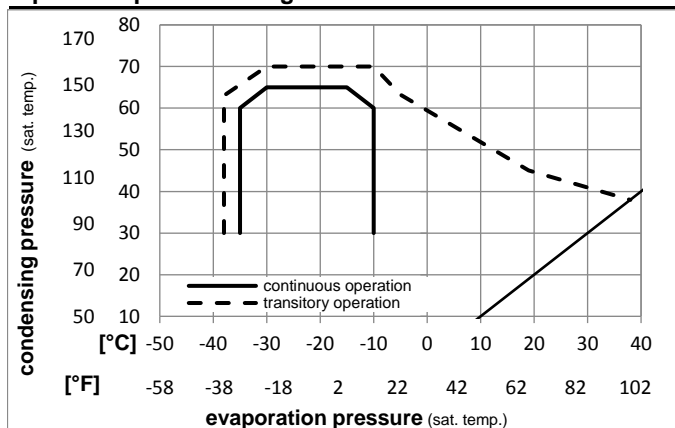

Components

- . terminal board (PTC,4.8mm,K100) **ZC F9**
- . run capacitor (4μF, 4.8/6,3mm) **cap. 4μF**
- . motor protector BDG AE 11 BJ x **AE11BJX**
- . cover + clamp + screws (Nr. 4ZN) **16168000**

Alternative components:

- . terminal board (PTC,6.3mm,K100) **DC F9**
- . run capacitor (4μF, 4.8/6,3mm) **cap. 4μF**
- . motor protector BDG AE 11 BJ x **AE11BJX**
- . cover + clamp + screws (Nr. 4ZN) **16168000**

Model

Designation	GTK80AT	200-240V/50Hz	Conf. 1	Sales code: CDO00155
-------------	----------------	----------------------	----------------	-----------------------------

Optimization + standard conditions

200-240V/50Hz 1~, RSCR, static, VDE, EAC

	Evaporating pressure (saturation temperature)				Condensing pressure (saturation temperature)			Return gas temp.			Liquid temp.			Cooling capacity			COP	EER	Power consumption			ASHRAE LBP
	pe	pc	RGT	Tliq	[W]	[Btu/h]	[kcal/h]	[W/W]	[Btu/W/h]	[kcal/Wh]	P1	I	m	[W]	[A]	[kg/h]						
[°C]	-23,3	54,4	32,2	32,2	231,5	791	199,2	1,60	5,46	1,38	144,8	0,66	4,49									
[°F]	-10	130	90	90																		
[°C]	-25	55	32	55	170,5	582	146,7	1,23	4,19	1,06	138,8	0,63	4,08								cecomaf LBP	
[°F]	-13	131	89,6	131																		
[°C]	-35	40	20	40	121,3	414	104,4	1,16	3,96	1,00	104,7	0,48	2,66								EN12900 LBP	
[°F]	-31	104	68	104																		
[°C]	-23,3	48,9	4,44	48,9	190,7	651	164,1	1,35	4,62	1,16	141,1	0,64	5,04								ARI540 LBP	
[°F]	-10	120	40	120																		
[°C]	-23,3	40,6	32,2	32,2	253,4	865	218,0	1,87	6,39	1,61	135,4	0,66	4,92								AHAM LBP	
[°F]	-10	105	90	90																		
[°C]	-35	45	32	45	112,9	386	97,2	1,06	3,62	0,91	106,4	0,46	2,44								opt	
[°F]	-31	113	89,6	113																		

Performance tables

200-240V/50Hz 1~, RSCR, static, VDE, EAC

	pe	Cooling capacity			COP	EER	P1	I	m		
	[°C]	[°F]	[W]	[Btu/h]	[kcal/h]	[W/W]	[Btu/W/h]	[kcal/Wh]	[W]	[A]	[kg/h]
[°C / °F]	-35	-31	112,9	386	97,2	1,06	3,62	0,91	106,4	0,46	2,44
cond. pressure	-30	-22	154,5	528	133,0	1,31	4,47	1,13	118,2	0,54	3,34
pc= 45/113	-25	-13	203,5	695	175,2	1,53	5,23	1,32	132,8	0,62	4,41
return gas temp.	-23,3	-10	222,2	759	191,2	1,61	5,48	1,38	138,4	0,65	4,82
RGT= 32/90	-20	-4	261,7	894	225,2	1,75	5,97	1,50	149,7	0,71	5,68
liquid temp	-15	5	330,7	1129	284,6	1,97	6,73	1,70	167,8	0,81	7,21
Tliq= 45/113	-10	14	412,5	1409	355,0	2,21	7,55	1,90	186,6	0,90	9,03
[°C / °F]	-35	-31	85,6	292	73,7	0,80	2,73	0,69	107,1	0,45	2,04
cond. pressure	-30	-22	125,3	428	107,8	1,03	3,53	0,89	121,3	0,53	2,99
pc= 55/131	-25	-13	170,5	582	146,7	1,23	4,19	1,06	138,8	0,63	4,08
return gas temp	-23,3	-10	187,4	640	161,3	1,29	4,40	1,11	145,3	0,66	4,48
RGT= 32/90	-20	-4	222,9	761	191,8	1,41	4,80	1,21	158,6	0,73	5,35
liquid temp	-15	5	284,4	971	244,8	1,58	5,39	1,36	180,0	0,84	6,85
Tliq= 55/131	-10	14	356,8	1218	307,1	1,76	6,02	1,52	202,3	0,95	8,63

Model

Designation	GTK80AT	200-240V/50Hz	Conf. 2	Sales code:	CDO00155
-------------	----------------	----------------------	----------------	-------------	-----------------

Configuration

Motorconfiguration	RSIR
Power supply (nominal)	200-240V/50Hz 1~
Refrigerant	R134a
Application	LBP
Voltage range	170-264V
Starting torque	LST
Approvals	VDE
	EAC

Electrical accessories / wiring diagram

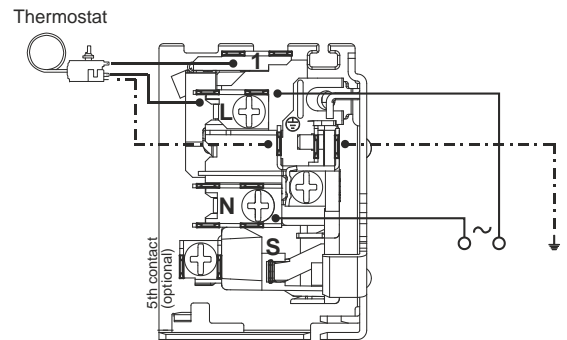
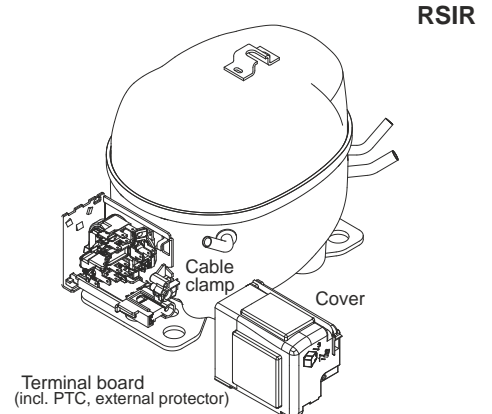

Ambient temperatures / system cooling

Ambient temperature min.:	10°C / 50°F
Ambient temperature max.:	43°C / 110°F

System cooling			
T ambient	LBP	MBP	HBP
32°C / 90°F	static	n/a	n/a
38°C / 100°F	static	n/a	n/a
43°C / 110°F	static	n/a	n/a

Operation pressure range

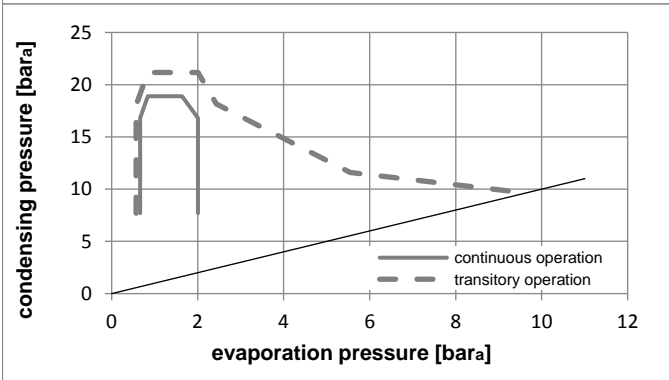
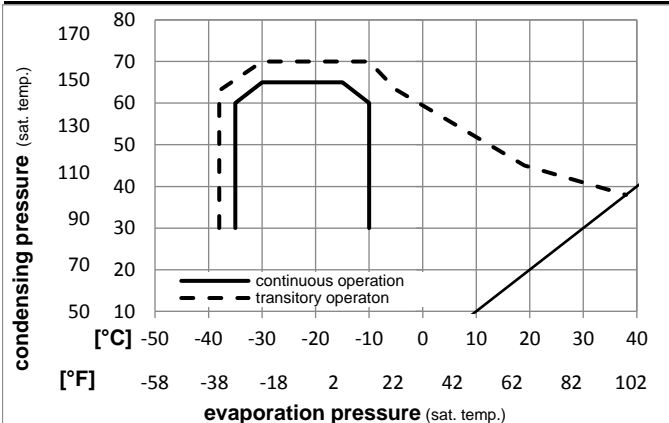

Components

terminal board (PTC,4.8mm,K100)	ZC F9
motor protector BDG AE 11 BJ x	AE11BJX
cover + clamp + screws (Nr. 4ZN)	16168000

Alternative components:

terminal board (PTC,6.3mm,K100)	DC F9
motor protector BDG AE 11 BJ x	AE11BJX
cover + clamp + screws (Nr. 4ZN)	16168000

Model

Designation	GTK80AT	200-240V/50Hz	Conf. 2	Sales code: CDO00155
-------------	----------------	----------------------	----------------	-----------------------------

Optimization + standard conditions

200-240V/50Hz 1~, RSIR, static, VDE, EAC

	Evaporating pressure (saturation temperature)				Condensing pressure (saturation temperature)			Return gas temp.		Liquid temp.		Cooling capacity			COP	EER	Power consumption		Ref. mass flow	
	pe	pc	RGT	Tliq	[W]	[Btu/h]	[kcal/h]	[W/W]	[Btu/Wh]	[kcal/Wh]	P1	I	m							
[°C]	[°C]	[°C]	[°C]	[W]	[Btu/h]	[kcal/h]	[W/W]	[Btu/Wh]	[kcal/Wh]	[W]	[A]	[kg/h]								
[°C]	-23,3	54,4	32,2	32,2	231,4	790	199,2	1,52	5,18	1,31	152,5	0,73	4,49						ASHRAE LBP	
[°F]	-10	130	90	90																
[°C]	-25	55	32	55	170,4	582	146,7	1,17	3,99	1,00	146,0	0,70	4,07						cecomaf LBP	
[°F]	-13	131	89,6	131																
[°C]	-35	40	20	40	120,9	413	104,1	1,11	3,78	0,95	109,2	0,51	2,65						EN12900 LBP	
[°F]	-31	104	68	104																
[°C]	-23,3	48,9	4,44	48,9	190,6	651	164,0	1,28	4,38	1,10	148,6	0,71	5,03						ARI540 LBP	
[°F]	-10	120	40	120																
[°C]	-23,3	40,6	32,2	32,2	252,8	864	217,6	1,77	6,05	1,52	142,8	0,68	4,91						AHAM LBP	
[°F]	-10	105	90	90																
[°C]	-35	45	32	45	112,6	384	96,9	1,01	3,46	0,87	111,0	0,53	2,43						opt	
[°F]	-31	113	89,6	113																

Performance tables

200-240V/50Hz 1~, RSIR, static, VDE, EAC

	pe	Cooling capacity			COP			EER			P1	I	m
	[°C]	[°F]	[W]	[Btu/h]	[kcal/h]	[W/W]	[Btu/Wh]	[kcal/Wh]	[W]	[A]	[kg/h]		
[°C / °F]	-35	-31	112,6	384	96,9	1,01	3,46	0,87	111,0	0,53	2,43		
cond. pressure	-30	-22	154,3	527	132,8	1,24	4,25	1,07	124,0	0,59	3,34		
pc= 45/113	-25	-13	203,3	694	175,0	1,45	4,96	1,25	140,0	0,67	4,40		
return gas temp.	-23,3	-10	221,9	758	191,0	1,52	5,20	1,31	145,9	0,70	4,81		
RGT= 32/90	-20	-4	261,3	892	224,9	1,65	5,65	1,42	157,9	0,76	5,68		
liquid temp	-15	5	330,1	1127	284,1	1,86	6,36	1,60	177,2	0,85	7,20		
Tliq= 45/113	-10	14	411,6	1406	354,2	2,09	7,14	1,80	196,9	0,95	9,01		
[°C / °F]	-35	-31	85,2	291	73,3	0,77	2,61	0,66	111,4	0,55	2,03		
cond. pressure	-30	-22	125,1	427	107,7	0,98	3,36	0,85	127,1	0,62	2,98		
pc= 55/131	-25	-13	170,4	582	146,7	1,17	3,99	1,00	146,0	0,70	4,07		
return gas temp	-23,3	-10	187,4	640	161,2	1,23	4,18	1,05	152,9	0,73	4,48		
RGT= 32/90	-20	-4	222,8	761	191,8	1,33	4,55	1,15	167,1	0,80	5,34		
liquid temp	-15	5	284,2	971	244,6	1,50	5,11	1,29	189,9	0,90	6,84		
Tliq= 55/131	-10	14	356,2	1217	306,6	1,67	5,70	1,44	213,4	1,01	8,61		